



BOON EDAM
YOUR **ENTRY** EXPERTS.



at

MEDIUM LEVEL SECURITY



TOUCHLESS.
ENTRANCE SOLUTION



LIFELINE SPEEDLANE SWING.

THE **NARROW** SECURITY LANE

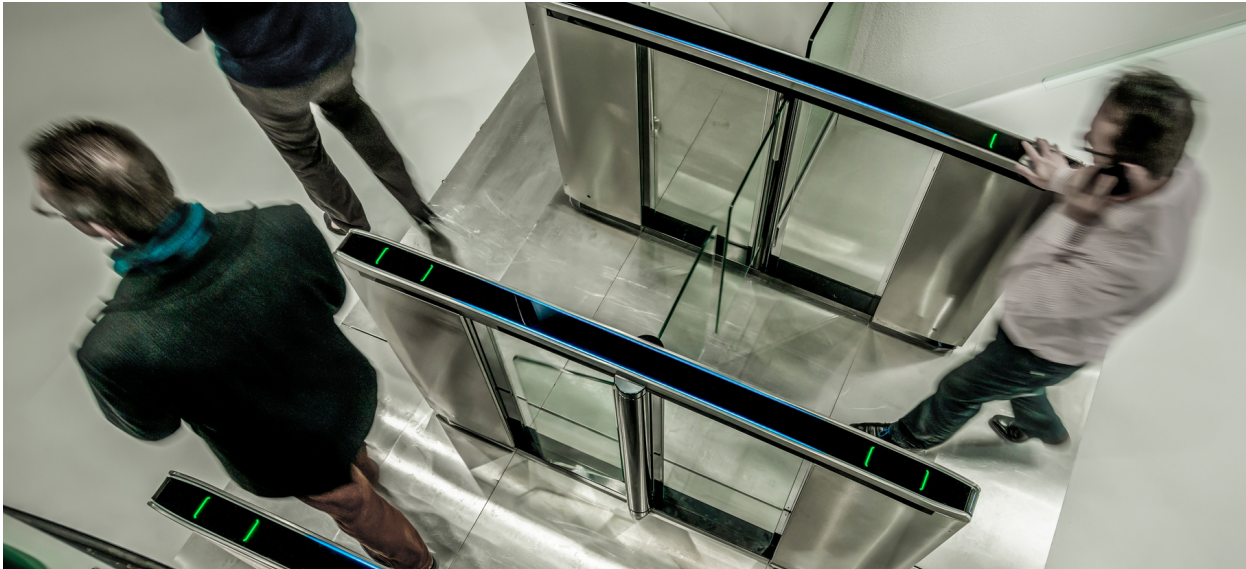

OVERVIEW

Changing work and public space environments have to keep up with larger numbers of people entering existing smaller space, with the obvious rising security concerns surrounding busy spaces.

The Lifeline Speedlane Swing speed gate seamlessly guides large groups of people safely onto the next point of their journeys using sophisticated and intuitive sensors and modern technology.

SOPHISTICATED, SLEEK AND SPACE-SAVING

The Lifeline Speedlane Swing is the narrowest gate in the Lifeline family, and one of the most slender in the market. This, combined with the fact that it is highly customisable, opens up a world of possibilities to the security manager – who is tasked with providing a medium security solution to a high flow area. The Lifeline Speedlane Swing acts as a boundary between public and private environments and does so with finesse.

THE PREFERRED CHOICE FOR COMPACT AESTHETICS

The Lifeline Speedlane Swing has been thoughtfully crafted with design aesthetics in mind. The smooth, premium glass casing houses intuitive-coloured LED lights which effortlessly glide along the cabinet top, guiding users from entry through authorisation to the secured area. This product effectively detects tailgating, and the aesthetics can be easily adjusted to either blend in or stand out, depending on your needs.

KEY FEATURES

- Intuitive approach detection
- Intelligent user guidance
- Tailgating detection
- Smooth, swinging-motion glass barriers
- Slim, V-shaped, tapered cabinets with ergonomic design and small footprint
- Premium quality materials
- Flexible lane configurations
- Low-energy, "sleep" mode
- Universally understood and proven display symbols
- Additional flexible options available to fine-tune or 'Level Up' (see page 4/5)

KEY BENEFITS

- Relieves pressure from security or reception staff
- Coordinates beautifully with existing building décor and design
- Allows smaller lobbies to incorporate physical security entrances
- Built to last

SUGGESTED SEGMENTS

- Corporate offices
- Multi-storey tenant buildings
- Medical and pharmaceutical facilities
- Schools, universities and colleges
- Sports facilities
- Government and embassy buildings



PUTTING THE POWER BACK IN YOUR HANDS

One size does not fit all, and that is why we at Boon Edam believe in offering modular solutions. This approach allows the security professional to design a tailored entrance solution that balances security and safety with aesthetics.

The result is a unique entrance that fits the needs of each industry, application and individual company. To get started, choose from an array of quality standard options. Then, 'Level Up' where it matters most to your company – whether that be in terms of throughput, security, safety, aesthetics, technology or user comfort – or a combination of each. A modular solution approach truly puts the power back into your hands - the power to create a refined entry with ease.

SCALABLE FLEXIBILITY IS THE FUTURE

The ability to integrate a large variety of secondary security technology into our speed gates is the ideal way in which to fine-tune by 'Levelling Up' their entrance security when increased protection is required.

Meeting your security goal easily and within your budget is the reason why we work together with you to ensure that by using these options, you end up with a product that outperforms the others safely, beautifully and profitably.

You can level up in any of these categories:

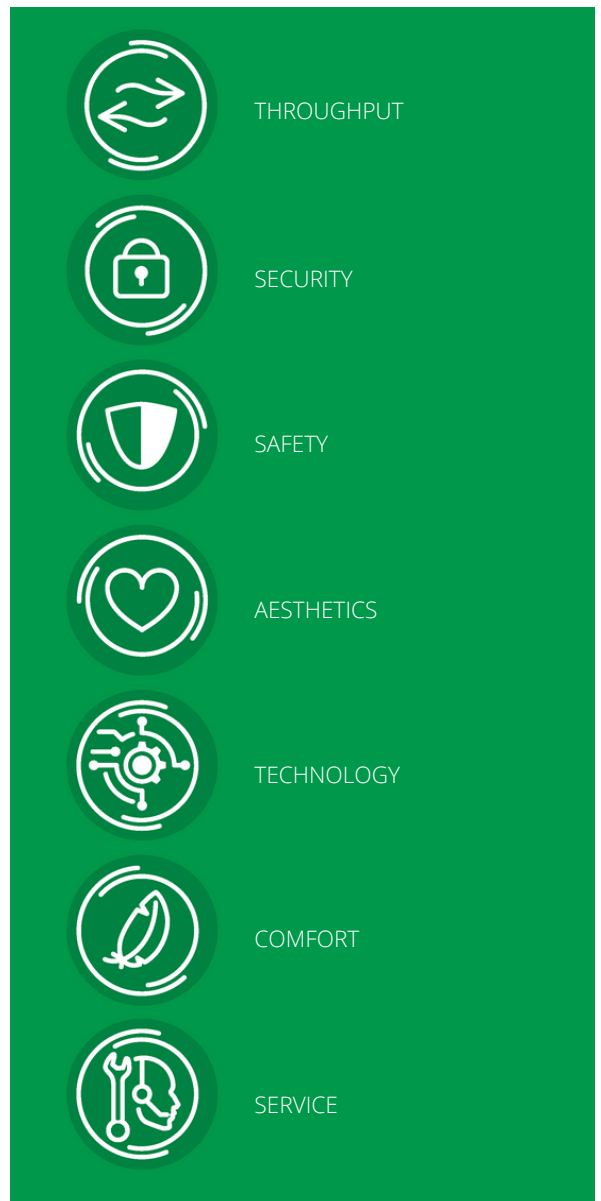

LEVEL UP



If our standard specifications do not quite suit your needs, we open up opportunities for you to 'Level Up' where it counts most. You can also do this according to your most motivating value driver.

The specification table shows you our standard product options, and to the right of these, you can easily see, and consider, any compatible 'Level Up' options for fine-tuning the Lifeline Speedlane Swing.



TECHNICAL SPECIFICATIONS

 THROUGHPUT	STANDARD	LEVEL UP OPTIONS
Throughput	20 - 30 People per minute	
Cabinet Width	106 mm / 4-1/8"	
Cabinet Height	1035 mm / 40-3/4"	
Cabinet Length	1776 mm / 69 - 7/8"	
Passage Width	615 mm / 24-1/4" (2 wings)	Narrow: 500 mm / 19-11/16" (1 wing) Wide: 915 mm / 36" (2 wings)
Overall Lane Width	827 mm / 32-1/2" (2 wings) (for a single lane)	Narrow: 712 mm / 28" (1 wing) Wide: 1127 mm / 44-3/8" (2 wings)
Wing / Barrier Height	940 mm / 37"	High options available: see pg. 6
 SECURITY	STANDARD	LEVEL UP OPTIONS
Unauthorised User Detection	Standard sensor set	Extra Jump-over detection
Booking Signal	Adjustable booking signal	
Sound Alarm	Standard buzzer	Sound module
Tailgating Detection	Standard Range	Tailgate+
 SAFETY	STANDARD	LEVEL UP OPTIONS
Fail Safe Operation	In case of power outage	
Fire Alarm Connection	Emergency egress settings depending on local regulations and or customer request	
Safety Sensors	Standard	Area/range can be fine-tuned
 AESTHETICS	STANDARD	LEVEL UP OPTIONS
Cabinet Material	Stainless steel	
Cabinet Colour	Standard stainless steel	Other Colours: On special request Branding: On special request
 TECHNOLOGY	STANDARD	LEVEL UP OPTIONS
Power Supply	110-240 VAC, 50 / 60 Hz	INTEGRATION OPPORTUNITIES:
Operating Power	80W	<ul style="list-style-type: none"> Lifeline Boost Mount (3 options) Facial Recognition Integration Top Mount (universal mounting plate) Universal Elevator Destination Display (max. 8 elevators) Schindler PORT 4 mini BoonTouch External Control Panel (up to 6 lanes)
Operating Temperature	-15°C / +5°F to +50°C / +122°F	
Weight	100 Kg / 220.4 lbs	
Access Control Systems	Dry contacts for virtually any access control device	
Card Reader Mount	Under the top of the cabinet. Max. dimensions: 55 x 130 x 50 mm / 2" x 5" x 2" (WxLxH)	
 COMFORT	STANDARD	LEVEL UP OPTIONS
Disabled Access	Wide passage width option suitable for disabled access	Winglock Swing access gate Passage width 915 mm / 36"
Intuition	Approach sensors, Feedback signals Lifeline LED guidance	
Stand-by Power Consumption	Stationary 60W, Sleep Mode 40W	

6 WORKING PRINCIPLE

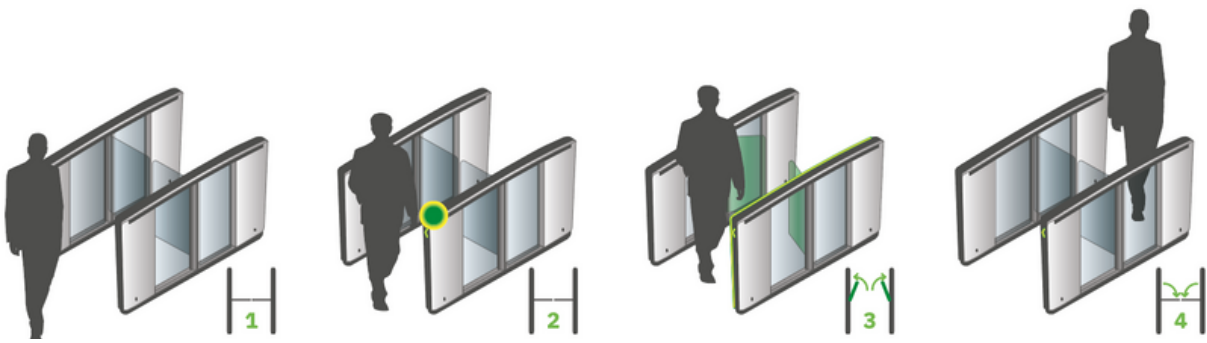

TECHNICAL DIMENSIONS

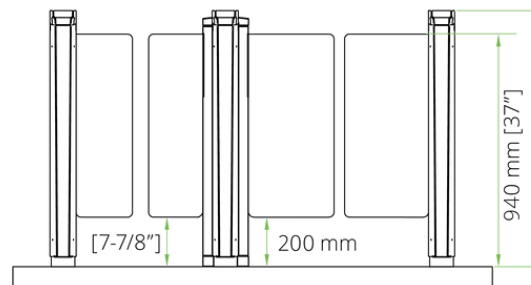
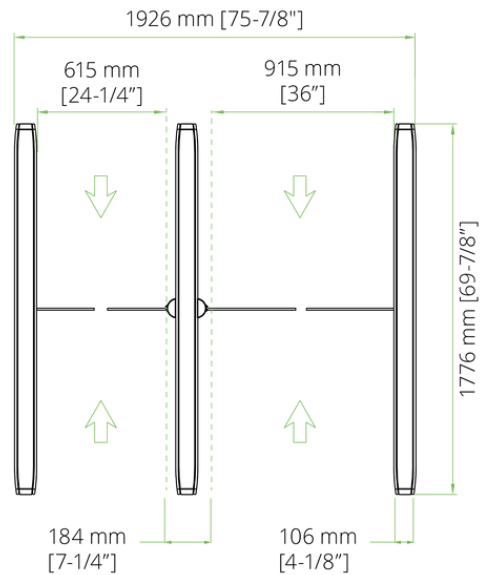
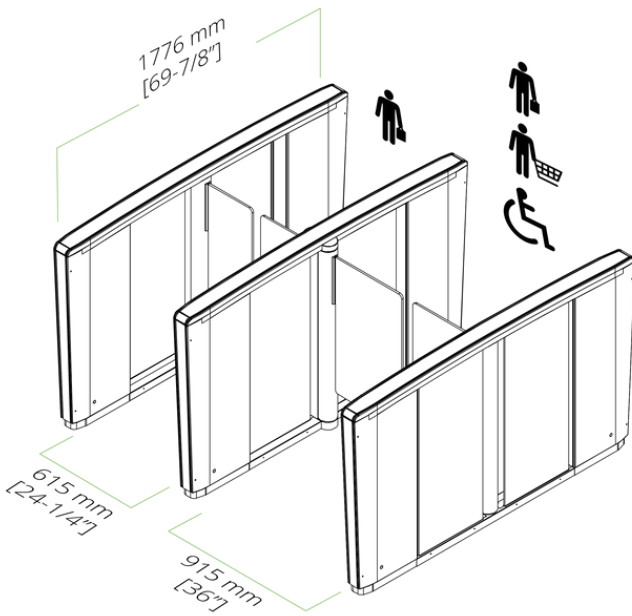
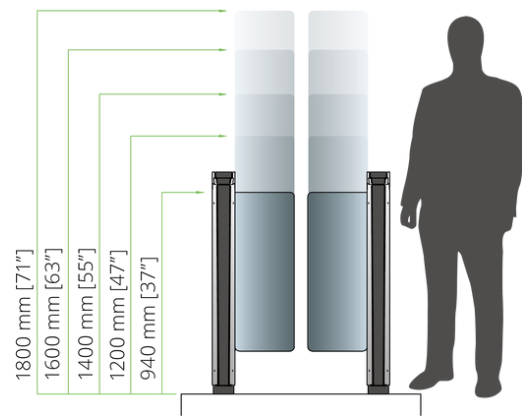



SERVICE AND MAINTENANCE

With hundreds or thousands of visitors passing through an entry every day, continued and reliable operation is vital. Regular service and maintenance can prevent unexpected hardware breakdowns. Boon Edam's service and maintenance teams across the world are experienced in the effects the local conditions have on the wear and tear of your entry solutions and can offer specialised service and maintenance contracts that correspond to those conditions perfectly.

COMPLIANCE

The goal of an organisation is to safeguard the valuable assets inside – both people and property. As is often the case, industries must comply with relevant local and global laws, policies and regulations, to achieve the important goal of overall safety and security. Failure to meet the appropriate measures and criteria set out in these regulations could result in catastrophic incidents and substantial fines.

Boon Edam security entrances are trusted solutions that allow organisations to meet compliance regulations related to restricting access to areas within a building. We take compliance and safety very seriously and ensure that our products are manufactured, installed and maintained to keep up the strict criteria required in all our countries. We are always improving and always committed to making sure our products are compliant and certified. More information can be found on our website under 'About Us'.

The Lifeline Speedlane Swing complies with the following European standards:

- Machine Directive (2006/42/EC)
- EMC Directive (2004/108/EC)
- RoHS Directive (2011/65/EU)



OUR REACH IS GLOBAL.

We have been in business for 150 years manufacturing premium aesthetic and security entrance solutions in the Netherlands, United States of America and China. We can confidently say that we cover every corner of the globe with subsidiary companies in major cities across the globe. Furthermore our global export division not only partner with our distributors, but also offer direct sales and service to every territory. This wide net allows us to have a strong global footprint as well as a personal grasp of local markets and their unique entry requirements.

To find your closest Boon Edam expert, please go to:
www.boonedam.com/contact



Royal Boon Edam International B.V.

T +31 (0) 299 38 08 08

E info@boonedam.com

I www.boonedam.com

V1-2211

BOON EDAM
YOUR **ENTRY** EXPERTS.